

**The premium
door.**



CarTeck sectional doors for life

With safety, design, and comfort

Teckentrup – in the market for more than 80 years – is one of the leading suppliers of doors and gates for industrial applications. This has made us a specialist in the area of especially robust security technology. Tried and tested know-how and cutting edge technology provide the foundation for the high level of reliability of our sectional garage doors. Quality: Made in Germany.

In order to ensure this high standard and at the same time fulfill our responsibility for the environment and sustainability, we have certified ourselves early in accordance with the ISO standards for quality and energy management. So whether you're renovating or building anew: Garage doors? In safe hands with Teckentrup.



Kai Teckentrup
Geschäftsführer/Inhaber



Meinolf Funkenmeier
Geschäftsführer

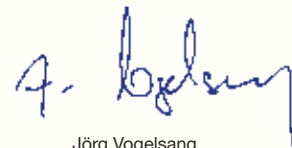

Jörg Vogelsang
Geschäftsführer

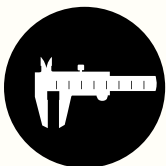

MADE IN GERMANY

Wealth of experience. In safe hands with Teckentrup.



Whether commercial or private property owners: Anyone building a new property or renovating a building must be able to rely on tried & tested solutions – on technologies which can be optimally adapted to the structural conditions.

This also applies in the field of garage doors. With its GSW 40-L sectional garage door, Teckentrup offers a fully professional product which gives you maximum flexibility in configuring your house. This is provided by individual dimensions and a high variability of styles, surfaces, colours, glazing elements, and applications. So however you're planning your new building or renovation – the GSW 40-L provides the perfect solution.



For renovators. And new builders.

Table of contents

Introduction	4
New builders	6
Renovators	7
Installation situation	8-9
Manufacturing quality	10-11
Maintenance of value	12-13
Security	14-15
Warranty	16-17
Comfort solutions	18-19
Online configurator	20-21
Overview of styles	22
Overview of surfaces	23
Door styles	24-25
Application example Rib	26-29
Application example Centre ribbed	30-33
Application example Unribbed	34-37
Application example Cassette	38-41

GSW 40-L

Glazing options	42-43
Colours	44-45
Applications	46-47
Solid wood	48-49
Side doors / wicket doors	50-51
Quality	52
European Competence	53
Patents, technology	54-55
Performance characteristics	56-57
Model overview	58-59
Installation dimensions / Door sizes	60-61
Installation dimensions / Door sizes	62
Product spectrum	63



UP TO 5,5 METERS

UP TO 3 METERS

+ FOR EVERY INSTALLATION SITUATION

+ MORE SPACE IN FRONT OF AND INSIDE THE GARAGE

+ WIDER PASSAGE

1 Exact fit dimensions

Whether you're renovating or building anew - the GSW 40-L fits perfectly into every installation situation. Door widths of up to 5.5 m and door heights of up to 3 m. A real premium door: Exact fit, superbly manufactured, and comfortable.

12 reasons for the GSW 40-L premium door.

A garage door is a purchase for life. Whether a new build or renovation.



2 More space in front of and inside the garage

Away with the old garage up-and-over door – and then? Our tip: Choose a modern sectional door. It requires much less space when opening and closing. This way you gain more parking space in front of and inside the garage compared with the up-and-over door and you can park your car directly in front of the door.

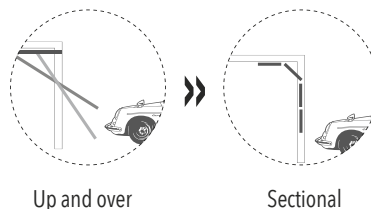

Up and over

Sectional

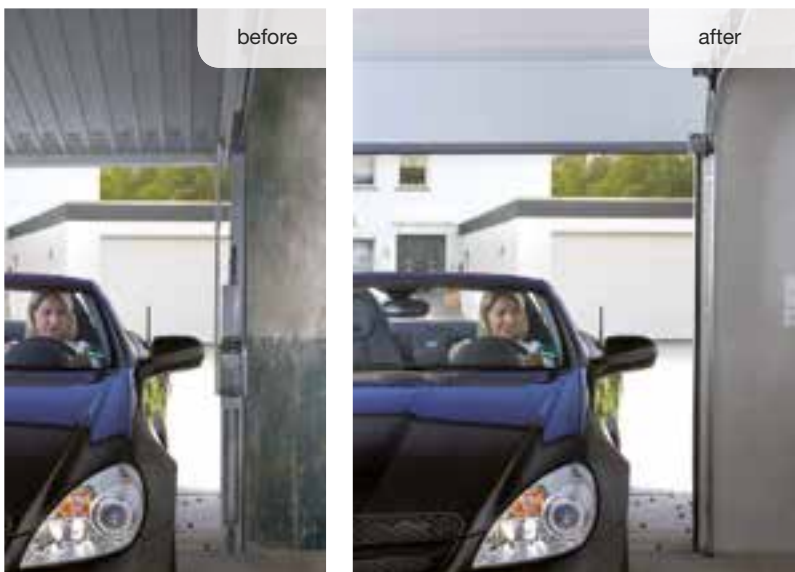

before

after

3 Easier parking

Modern cars are wider than they were 20 years ago and with the old up-and-over doors it is difficult for them to drive in and out of the garage. This often leads to the paintwork getting damaged. With a CarTeck sectional door, you will gain more space at the sides because there is no longer a space-consuming lever mechanism as was the case with an up-and-over door.

The right solution for every taste.

An old garage and a new door – do they go together?
Absolutely! Refined renovation solutions make sure of this.



4 Renovation solutions

Independent of the building situation –
Teckentrup offers special fastening and cover plate sets with
which your new sectional door can be easily installed.

Our frames accommodate all building situations, our cover
plates with widths of 85 and 120 mm cover the gaps between
the frame and the wall, and our special corner plates conceal
crumbling masonry. These create perfect solutions, which in
most cases make elaborate follow-up work by masons and
painters unnecessary.

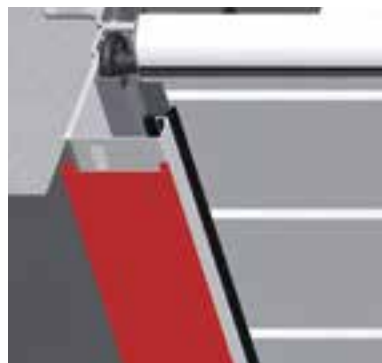

+ MATCHING FRAME

+ MATCHING DOOR LEAF

+ MATCHING COVER PLATE

+ MATCHING COLOURS



Whatever form your doorway takes: The premium door GSW 40-L is flexibly tailored to your demands - even in garages with very little headroom.



Precision manufactured - and hence visually perfect.

An even distribution of the ribs and covered section transitions guarantee a harmonious door styling.



5 Even panel transitions



Conventional doors

With many of our competitors doors, the different styling of the ribs and the joints between the sections provides an unharmonious overall impression.



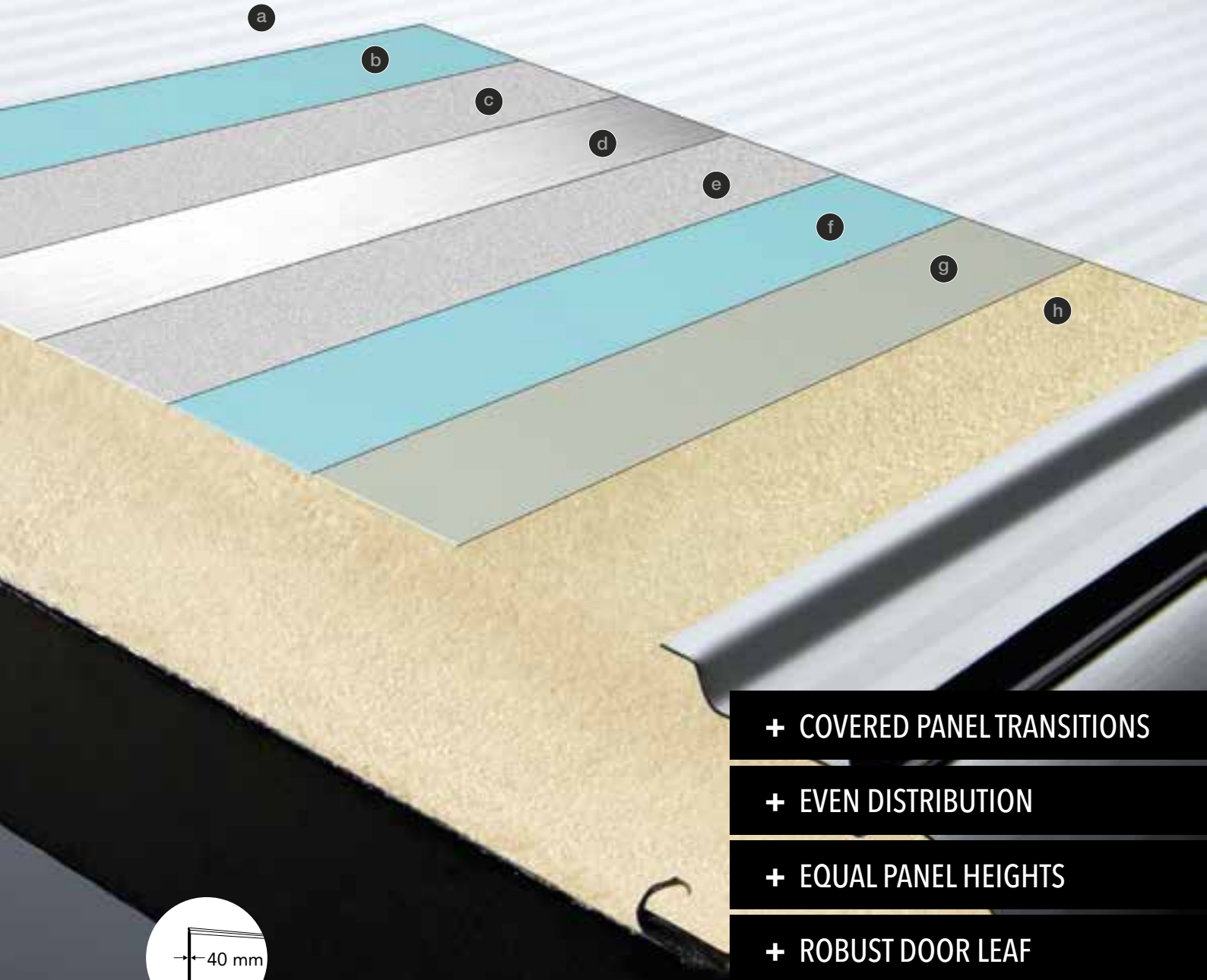

- + COVERED PANEL TRANSITIONS
- + EVEN DISTRIBUTION
- + EQUAL PANEL HEIGHTS
- + ROBUST DOOR LEAF

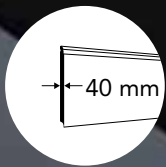

STABLE & THERMAL INSULATION

6 Superb manufacturing

Our door leaves comprise eight different layers, which give them extraordinary wear resistance and durability:

- (a) Sealed top coating
- (b) Highly effective adhesion primer
- (c) Corrosion-resistant galvanized coating
- (d) Special steel
- (e) Corrosion-resistant galvanized coating
- (f) Highly effective adhesion primer
- (g) Protective coat on rear side
- (h) Highly-stable core made of special foam with integrated thermal insulation

Protects your property throughout your lifetime.

With the GSW 40-L, wind and weather have no chance.
Effective protection for your car as well as your building.



7 Corrosion protection
A special plastic element separates the vertical frame sections from the floor. Whether after a rain shower or in the case of creeping dampness - the design ensures that the base area is always aerated, dries quickly, and is hence permanently protected against corrosion.

8 Durable surface protection
The galvanized garage door frames have a high-quality top coating. This protects the doors from external influences and they remain just as decorative after several years as they were on the first day.



OUTDOOR

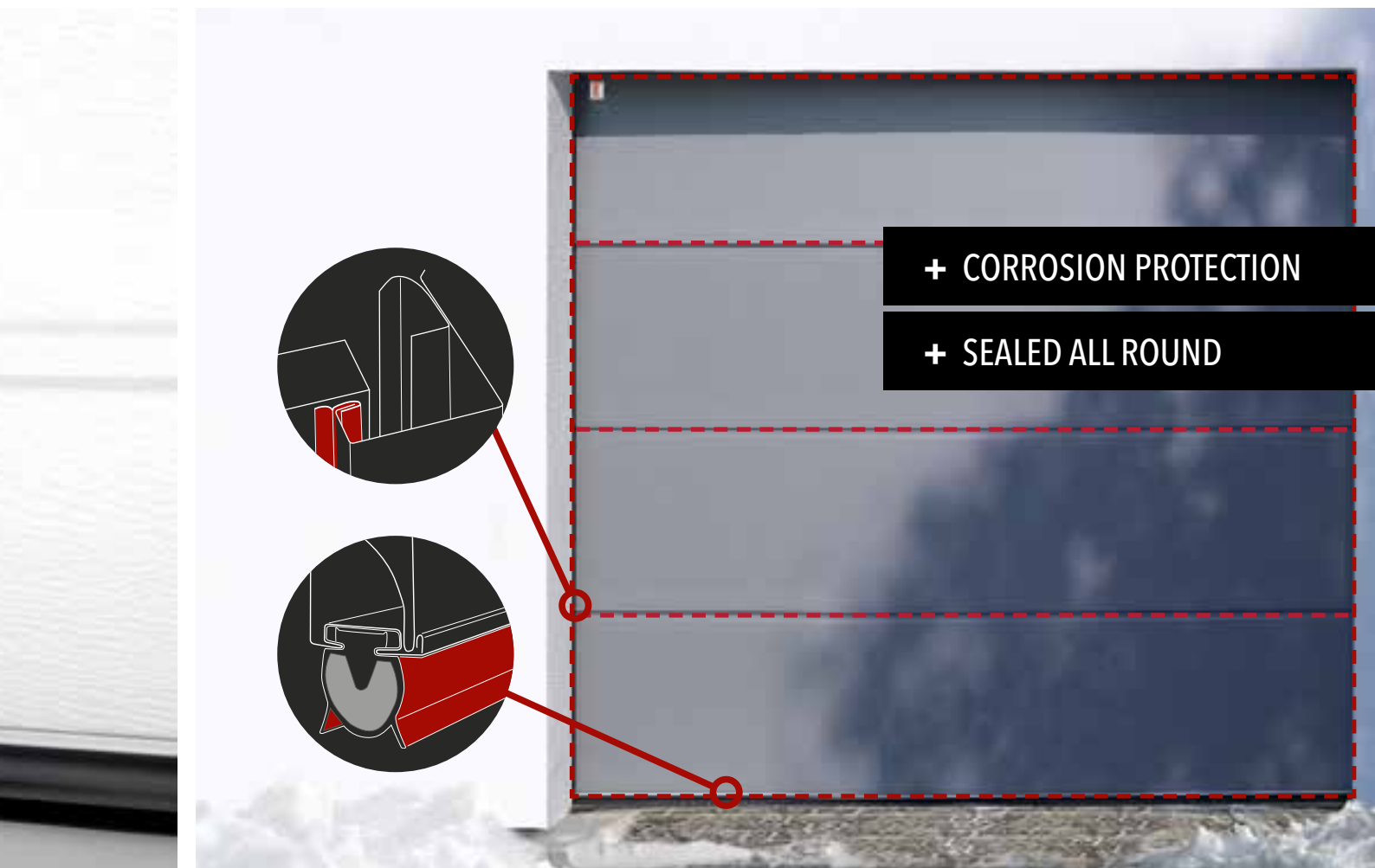

9 When closed, vertical frame seals, lintel, intermediate and bottom seals seal the door on all sides. This means that the garage is optimally protected from driving rain and penetrating dampness.

In addition, the 40 mm thick door leaf ensures optimum thermal insulation and minimized energy loss.



.....
The patented finger pinch protection protects you from injury.
The optional light barrier provides even more safety.



- + FINGER PINCH PROTECTION**
- + LATERAL INTERVENTION PROTECTION**
- + OPTIONAL LIGHT BARRIER**
- + BREAK-IN PROTECTION**



QUIET OPERATION



MORE PROTECTION FOR THE FAMILY



Everything considered in terms of security.

The sectional door combines maximum operating safety with break-in protection - for persons and valuables.

10 Quiet door operation

Innovative designs worked out in great detail, such as the rollers made from special plastic, provide for quiet opening and closing. Rattling door movements are a thing of the past.



11 Break-in protection

CarTeck sectional doors and the associated drives provide greater protection against unauthorized access. This is particularly important if valuables are stored in the garage or if there is a direct passage from the garage into the house.



12 Operational safety

Unightly, open torsion springs are history. In CarTeck sectional doors, the tension springs are guided in enclosed spring channels right underneath the ceiling. The springs are designed to balance the door weight without maintenance and to ensure an even door operation.



For increased demands with several door movements per day, we recommend our special high-performance springs with a manufacturer's warranty of 10 years.



350 kilos. 1 warranty.



No, we don't always park a Harley on our sectional door panels. But we do when we want to demonstrate the high stability and surface quality of our products to you. Robustness which means you will enjoy your garage door for a long time to come. And that's a promise. It's also the reason for our unique Teckentrup 5-point warranty.



5-POINT WARRANTY

5-year warranty on rollers, hinges, cable pulleys, cables, and standard springs, 10-year manufacturer's warranty on high-performance springs.

10-year manufacturer's warranty on panels combatting rust penetration from the inside out.

10-year manufacturer's warranty against separation of steel from foam.

10-year manufacturer's warranty on material and manufacturing flaws of all non-moving parts of the frame that are verifiably unusable or whose usability is substantially compromised.

10-year manufacturer's warranty on floor seal, intermediate seals, side seals, and lintel seal against rotting.

The full wording of the terms of the warranty can be found on our homepage at www.teckentrup.co.uk



**Designer hand-held transmitter
SH4-D black**

The black designer hand-held transmitter is included as standard with the CarTeck 20.2 and 40.2 drives.



Movement at the press of a button. Teckentrup offers a multitude of fixed and mobile transmitters to set your garage door in motion. Reliable security technology protects your property from intrusion by unauthorized persons.



**Designer hand-held transmitter
SH4-D white**

It's no problem if you need a second designer hand-held transmitter. Just order e.g. the white 4-channel transmitter including sleeves in high-quality gift packaging!



Optimum interplay.

An excellent combination: The hand-held transmitters with top design, the drives with top performance.



Intelligent drive technology

Our new door drives offer several comfort and security benefits:

So the operating code changes constantly – just like with online banking. This also increases break-in protection. In addition, our drives have an automatic force limitation which stops the door leaf when the door strikes an obstacle and immediately frees the obstacle again by reversing.

If necessary, a vent position ensures drying of the garage. And not least, an optional light barrier can be integrated into the controller. Our tip: Ask for our drive brochure with further attractive accessories!

You can find detailed information in our drive brochure.



Easy planning.
Online configurator.



The path to your dream door has never been so short!
Simply put everything together the way you want it at
www.teckentrup.co.uk

The online configurator leads you through the fascinating world of garage door configuration in a few simple steps. Whether it be styling, surfaces, colours, glazing elements and applications – in just a few clicks you can put together your dream garage door.

Then you can install it in the photograph of your garage and enjoy the view. On your own, with your partner or together with your family, and in peace and quiet.

Allow yourself to be inspired.

If you would like an offer on your configuration, then simply send us a request. You will promptly receive an offer via our trade partners in your vicinity.





.....
Styles

The CarTeck styles characterize the way your new garage door looks from afar.
.....

.....

„Ribbed“ style

.....

„Centre ribbed“ style

.....

„Unribbed“ style

.....

„Georgian“ style

Surface design: The first step towards your dream door.

With the combination of style and microstructure of the surface, you can design a garage door with its own unique character.

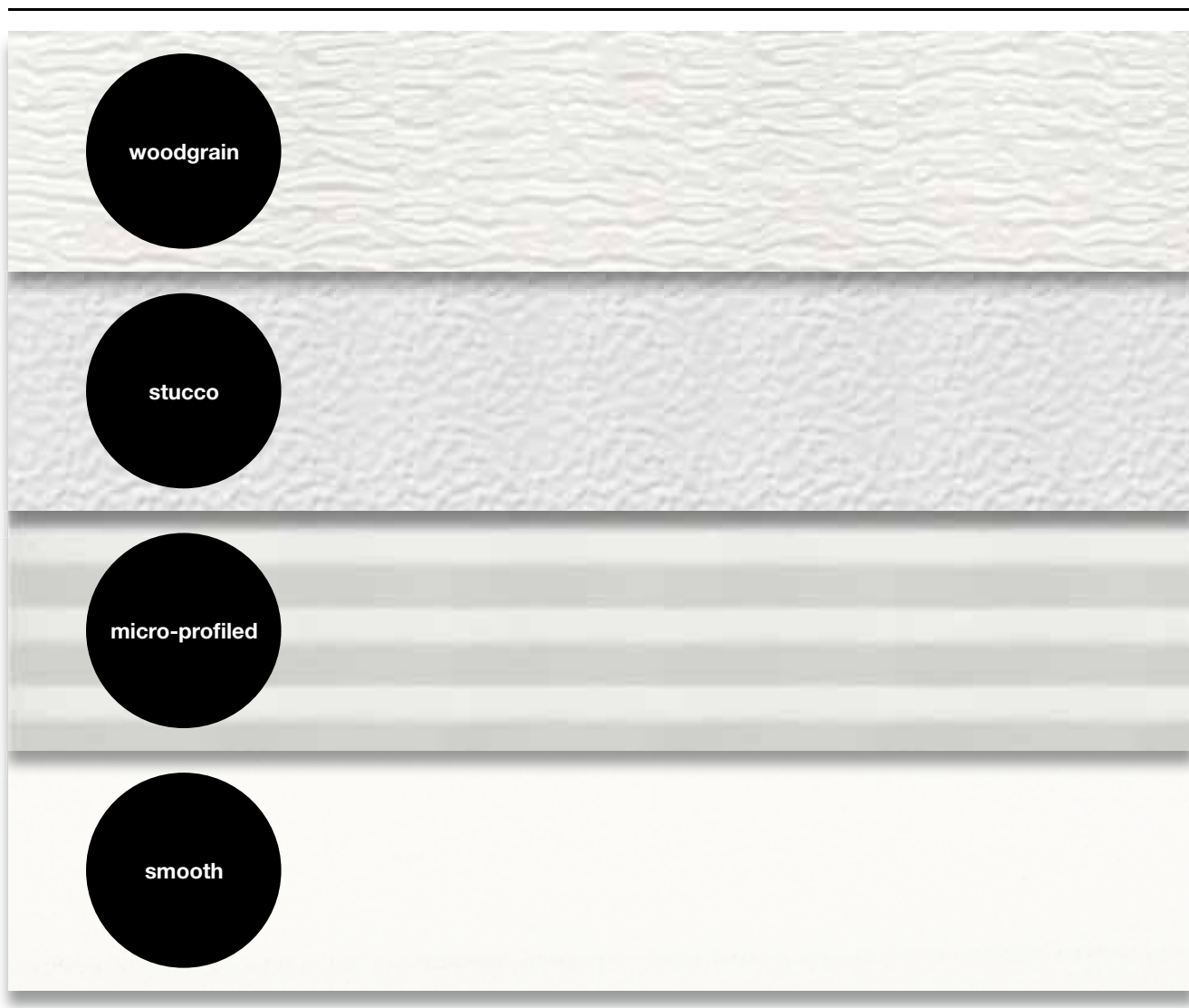

These four high-quality surfaces give the door leaf its visual edge.

.....
woodgrain

The surface with the wood-grain impression
.....

.....
stucco

The granular structure of the surface is reminiscent of a fine wall plaster.
.....

.....
micro-profiled

The fine lining harmonizes ideally with modern architectural styles.
.....

.....
smooth

Pure aesthetics that dispense with any surface structure.
.....

Door styling that characterizes architecture.

Surfaces styles, colours: Everything should be optimally coordinated and blend in harmoniously.



1 Ribbed



2 Centre ribbed

In addition to the colours, the styles have the strongest long-distance effect on observers. For this reason, they should consciously be matched to the style of your house. An unribbed door leaf suits a highly-modern facade

with clear lines, whilst the door leaf with Georgian harmonizes better with a classical architectural style. The choice is yours.



RAL of your choice



3 Unribbed



4 Georgian

Ribbed. Design with lines.





Ribbed. Applied diversity.

The ribbed style with an even distribution over the entire door leaf offers several design options.



Pure lifestyle.
Nowadays, an aesthetically-appealing garage door is part of a modern lifestyle.



The ribbed style with the classic „Golden Oak“ wood decor blends in harmoniously with a rustic architectural style.



In the case of smooth, homogenous facades, the ribbed style offers a delightful contrast.

Centre ribbed. Subtle features.





Space for two.
If you have several cars in the garage, this means more movements of the door.
Our robust sectional doors manage this with ease.

Centre ribbed. Applied diversity.

The centre ribbed style emphasizes the subtle features on the door leaf surface.



The design is of particular importance with the large surfaces of very wide garage doors



With the colour design, the GSW 40-L and the window frames offer a harmonious overall impression.



The weight of a door leaf increases with its width. Our new drive generation moves your CarTeck sectional door with accurately adjusted performance.

You can control your new CarTeck sectional door comfortably from a distance using a hand-held transmitter.

Unribbed. Timeless elegance.





Unribbed. Applied diversity.

Whether you are renovating or building anew – the CarTeck sectional door adapts to all architecture.





From the same mold.
Here the colours of the two garage doors opti-
mally blend into the overall appearance.



Modern line.
Here a deliberate contrast has been made in
terms of door colour and house facade.

Whether you are renovating or building anew – the CarTeck sectional door is also part of the exterior design.

Georgian. Classically elegant.





Georgian. Applied diversity.

The Georgian style characterizes not only the garage door, but the entire house appearance.



Individual style

The Georgian embossments on the door leaf are not only suited to classic architecture styles, but also to a wooden facade, as in this case.



Due to the uniform arrangement of the Georgian cassettes, the CarTeck sectional door also gains a harmonious overall impression. At the same time, the pattern can be excellently combined with our attractive glazing elements.



Mediterranean style.
In combination with the slightly-inclined roof, the attractive Georgian styling communicates a Mediterranean attitude to life. We supply this classic style with the elegant and durable surface „woodgrain“

Transparent configuration. Glazing elements.

Not only do glazing elements allow light into the garage. They also make a decisive contribution to the overall architecture of your house.



Whether as a harmonious integration or as a conscious contrast – glazing elements matched to the facade, side door, windows, or entrance door make a decisive contribution to the overall architecture of your house. As with all components, the glazing is extremely robust and impervious to scratches and other mechanical influences. The wide range of glazing types also leaves nothing to be desired.



Choose from three scratch-resistant plastic double panes – clear, with crystal structure, or satinized.

Sheer diversity. Glazing elements.



Rectangle 1



Rectangle 2 *



Cross mullion



Multiple mullion



Rhombus mullion

7 attractive glazing types with white polyurethane frame.

Available in the styles ribbed, centre ribbed, unribbed, cassette.

*not in the style „Cassette“



Aluminum light strip



Square 1*



Square 2*



Rectangle 3
www.thegaragedoorcentre.co.uk



Circular glazing (also in stainless steel)
0800 525 442

Additional glazing forms with white polyurethane frames are available for selection in the „Unribbed“ style.



Life is variegated. And so is our colour range.

Our colour range is as variegated as life. No question about it, you will find your favourite shade.

Our range gives you the full configuration scope to match the colour of your garage door to your facade, window frames or house door.

There are several factors to consider when selecting the colour of your garage door: You can adapt the colour to window and door frames. Or you can base it on the colour design of the facade. Or you can simply choose your favorite colour to your heart's content.

Large selection

15 popular colours, RAL colours by choice and attractive wood decors. As standard, the door leaf has the exterior colour Traffic White (RAL 9016) and the interior colour Grey White (RAL 9002).



Blazing Red
RAL 3000



Steel Blue
RAL 5011



Moss Green
RAL 6005



Fir Green
RAL 6009



Anthracite Grey
RAL 7016



Light Grey
RAL 7035



Quartz Grey
RAL 7039



Window Grey
RAL 7040



Sepia Brown
RAL 8014

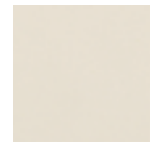

Creamy White
RAL 9001



Deep Black
RAL 9005

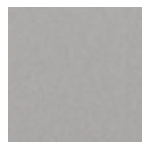

White Aluminum
RAL 9006



Grey Aluminum
RAL 9007



Grey tone
TT 703*



Brown tone
TT 8014*

Wood decors



Golden Oak

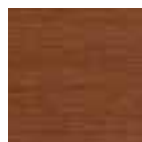

Dark Oak

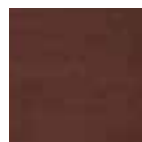

Rosewood



Winchester

For fast decision makers: The colour range shows you the 15 colours and 4 wood decors that are currently trending. However, you can also choose almost any other RAL colour.

Due to the printing process colours are only representations. RAL offers a guide to colour matching, materials, differing manufacturing processes and batches

* Colour tones with micaceous iron ore particles

Decoration for your garage door. Applications.

Our stainless steel decorative elements offer you even more options for designing your garage door.



Individual design

Even without glazing elements, the door leaf can be a blank canvas for individual design. The GSW 40-L „un-ribbed“ sectional door with a smooth surface allows configuration with stylish stainless steel applications. A wide range of high-quality motifs are available for you to choose from. The applications are also ideally suited to create visual uniformity between the garage door and the side door. In this way, you can give your facade ensemble an individual look with character.

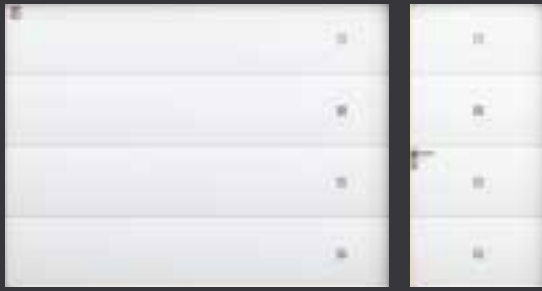

H1 Design #1

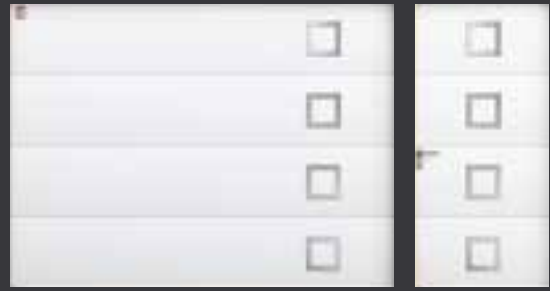

H10 Design #10

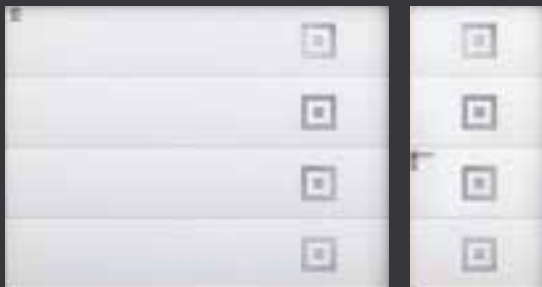

H11 Design #11

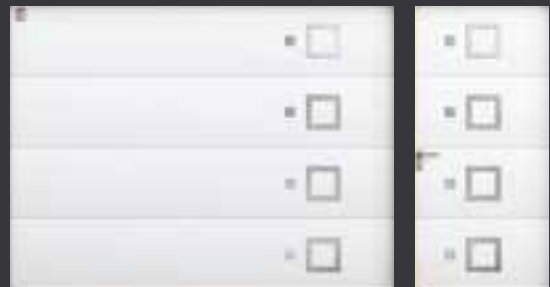

H101 Design #101

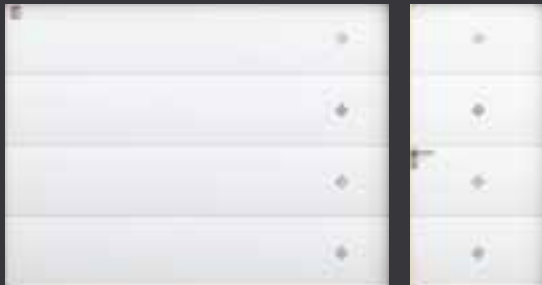

H2 Design #2



H20 Design #20



H22 Design #22



H202 Design #202



DESIGN

For individualists. GSH door made of solid wood.

Sectional doors made of real wood represent a high level of quality.





CarTeck GSH sectional door made from solid wood, in cassette styling.



Solid wood untreated

Solid wood stained Pine

Solid wood stained Spruce

Solid wood stained Teak

Solid wood stained Walnut

Solid wood

We have developed the GSH sectional door for individualists who have a particular preference for real wood. Choose between the wood types domestic spruce/fir and Hemlock and combine these with our different styles.

To protect against the influence of weather and UV radiation, all woods are also available in the colour tones pine, spruce, teak, walnut etc.

Timber is a natural product and as such variations in tone and colour maybe apparent.

More comfort. Side and wicket doors.

Side and wicket doors give you comfortable access to the garage, even without opening the door.



Whether it be a bicycle or a wheelbarrow - the garage side door is big enough to allow access for both.



If there is a secondary access to your garage, or if you have plans for one, just order a matching side door. Use the optional triple locking and protect your valuables in the garage even more effectively.



If there is no secondary access, a wicket door offers a real alternative and also protects from loss of heat as the entire door does not have to be opened each time.

Integrated access.
The wicket door in the door leaf permits access for people.

Quality „Made in Germany“

Established over 80 years ago in eastern Westphalia, the company has also been manufacturing since 1990 in Großzöberitz (Saxony-Anhalt).

Our CarTeck garage doors are manufactured on highly modern production lines.

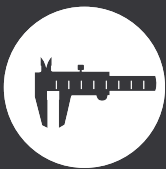
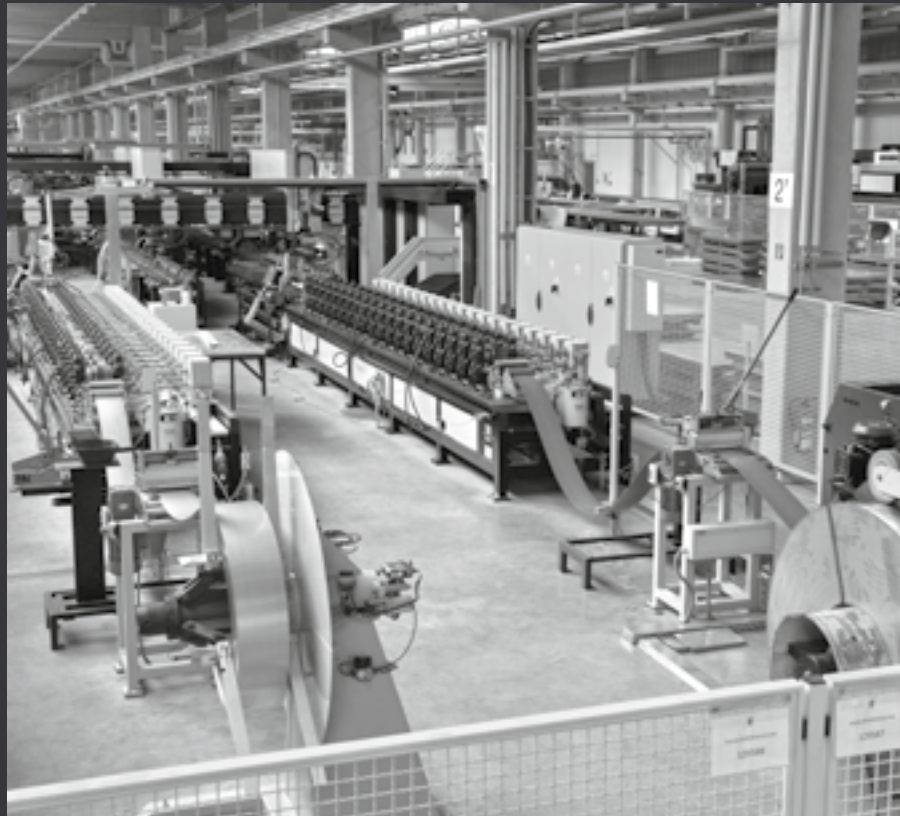

MADE IN GERMANY

With more than 900 highly qualified employees at our sites in Verl and Großzöberitz, we stand for product development and manufacture that is „Made in Germany.“ We only use first-class materials, we ensure precise production with highly-modern machinery, and we carry out continuous quality examinations within the framework of our quality management structure in accordance with DIN EN ISO 9001.

In 2012 we established integrated management systems with the elements Environment (DIN EN ISO 14001), Energy (DIN EN ISO 50001) and also Occupational Health and Safety (BS OHSAS 18001).

You can thus count on sustainable production and a particularly high standard of occupational health and safety.

At home in Europe.

International competence.

There is a good reason for Teckentrup's leading position in Europe: we have been active in the widest variety of markets for many years and we know their particular requirements very well. Our CarTeck sectional doors for private customers benefit from the extensive expertise from the field of industrial sectional doors. You can thus fully rely on our quality – e.g. with respect to mechanical requirements, thermal insulation, or operating safety. In the whole of Europe.

We combine „Made in Germany“ quality with European competence to produce an unbeatable advantage: wherever you plan your project, you can trust in the capability of one of Europe's leading manufacturers of high-quality doors.

Love of detail.

Patents, technology.

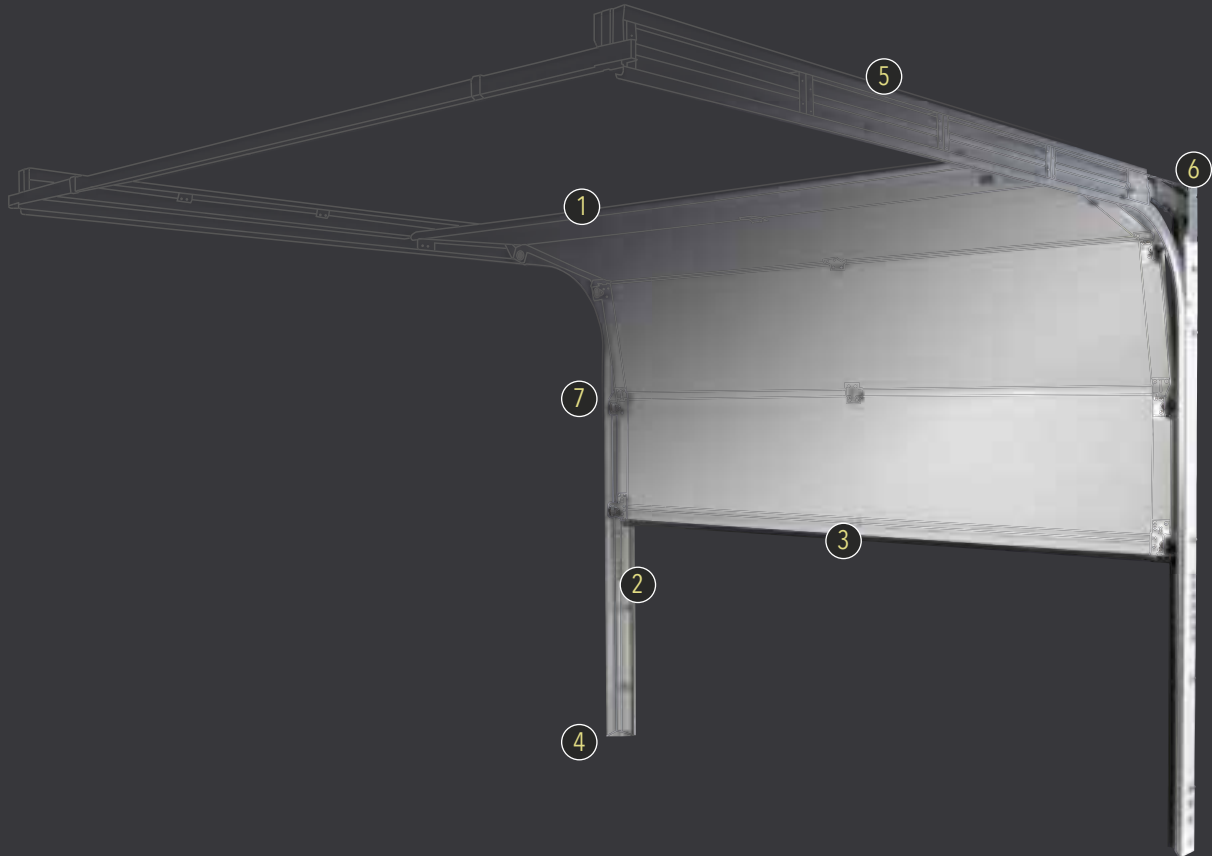

1 Thermal and rain protection

When the top section closes against the seal of the head plate the door will give maximum performance, delivering reductions in drafts, water penetration and resultant heat loss. Please note that the installation, and the construction of your garage, as well as local prevailing site conditions may have an affect on the performance of your new garage door.



2 Side seals

The sealing concept is continued here. Flexible seals on the frame legs have the dual function of again reducing drafts and water penetration with the dual function of stopping the door panels rattling against the door surface when the door is closed.



3 The multi-talent / floor seal

The elastic EPDM rubber profile floor seal combines 4 intrinsic advantages: It is resistant to the rotting process, remains flexible even in extremely cold conditions, and can compensate for some unevenness in the floor while also offering reduced water and draft penetration.



4 Corrosion protection / spacer

A special covered plastic element separates the vertical frame sections from the floor. Whether after a rain shower or in the case of creeping dampness – the design ensures that the base area is always aerated, dries quickly and is hence protected against corrosion.



5 Technology with profile / spring channel

In conjunction with special plastic sliding elements, the special profile configuration of the spring channel plates ensures that the sectional door runs very smoothly and quietly. If desired, we can supply special high-performance springs with a 10-year manufacturer's warranty. The enclosed design of the spring channel prevents the penetration of dirt and also increases durability.



6 Dual safeguard / multiple spring system

The multiple spring system optimally balances the door's weight in any situation. The dual supporting cables always reliably support the door even if a cable or spring is broken. This ensures smooth operation of the sectional door: It can also be opened and closed in emergencies.



7 Quiet door operation / roller support

The eccentric roller supports are patented by Teckentrup. They are made of wear-resistant special plastic. They provide maintenance-free function and at the same time muffle the sound of the door rollers, so that together with the profiled spring channels they contribute to quiet, barely-audible door operation.



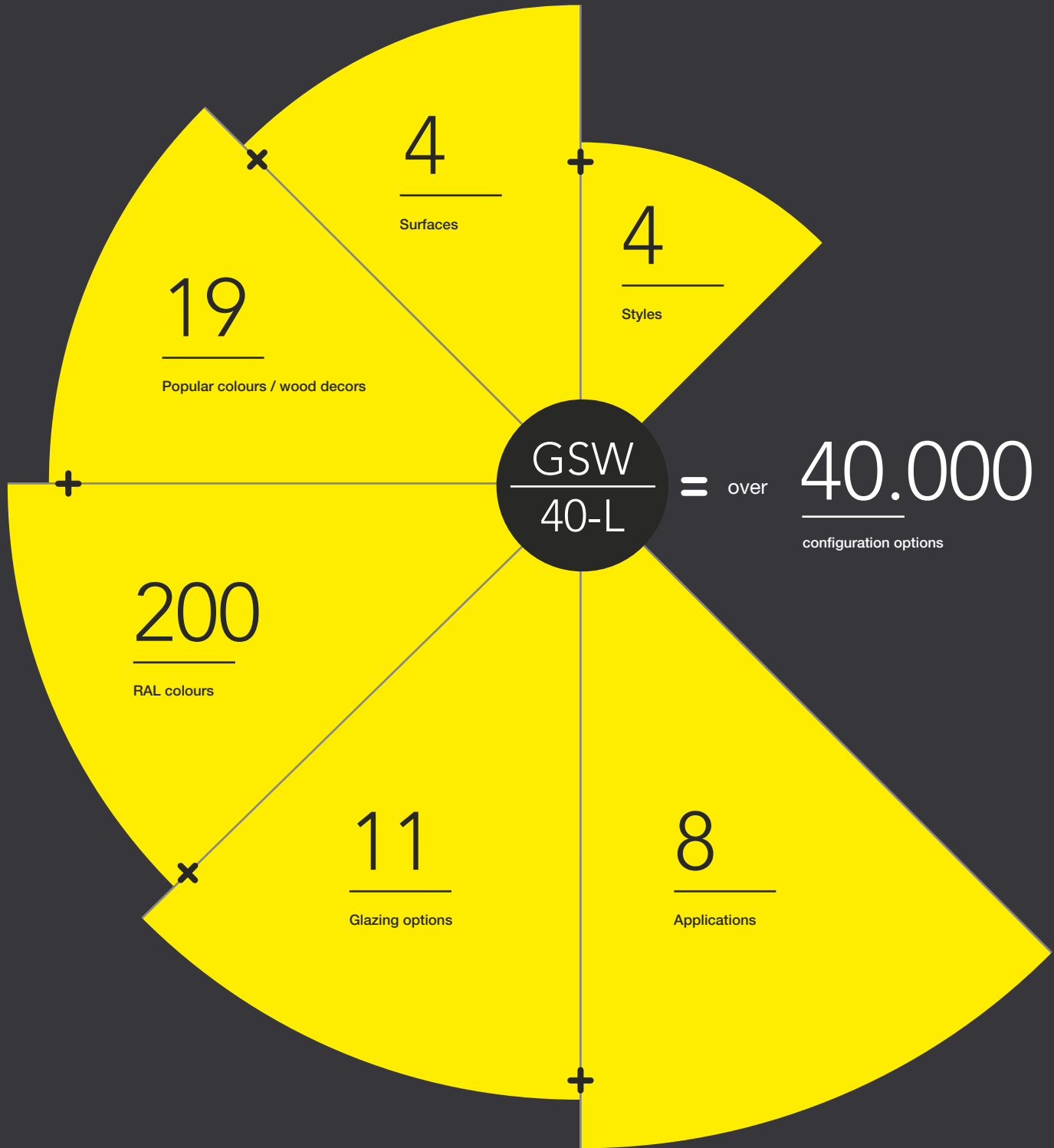

Performance characteristics

Thermal insulation (DIN EN ISO 12428)	Panel: $U_D = 0,56 \text{ W/m}^2\text{K}$ Door leaf without glazing: $U_D = 0,95 \text{ W/m}^2\text{K}$ Installed door: $U_D = 1,48 \text{ W/m}^2\text{K}^*$ <small>*10 m² door area without glazing</small>
Air permeability (DIN EN 12426)	Class 2
Wind load (DIN EN 12424)	Class 3
Impermeability to driving rain (DIN EN 12425)	Class 2
Fire behaviour (DIN EN 4102)	Door leaf element material class B2 (normally inflammable)

Freedom of choice.

GSW 40-L

performance characteristics

Overview	GSW 40-L								
Styles	Ribbed and centre ribbed				Unribbed				Georgian
Surfaces	woodgrain	stucco	micro-profiled	smooth	woodgrain	stucco	micro-profiled	smooth	woodgrain
15 popular colours	x	x	x	x	x	x	x	x	x
4 wood decors	-	-	-	x	-	-	-	x	x
approx. 200 RAL colours	x	x	x	x	x	x	x	x	x
Glazing variants	8	8	8	8	11	11	11	11	5
Design applications	-	-	-	-	-	-	-	8	-
Burglar resistance	standard				standard				standard
Finger pinch protection	standard				standard				standard
4-side seal	standard				standard				standard
Multiple spring channel	standard				standard				standard
High-performance springs	optional				optional				optional
Corrosion protection	standard				standard				standard
Multiple-spring Dual-cable system	standard				standard				standard
Patented eccentric roller brackets	standard				standard				standard
Wicket door	optional				optional				-
Side door	optional				optional				optional
Handle sets	optional				optional				optional
CarTeck drives	CarTeck 20.2 or CarTeck 40.2								
Designer hand-held transmitters Black	standard				standard				standard
Designer hand-held transmitters white + 4 sleeves	optional				optional				optional
light barrier	optional				optional				optional

Your options. Model overview.

Styles

Door widths of up to 5.5 m and door heights of up to 3 m in conjunction with four possible styles – with these options, you will definitely be able to find your dream door. We will also deliver a matching side door on request.
(Special dimensions on request)



„Ribbed“ style



„Centre ribbed“ style



„Unribbed“ style



„Cassette“ style

Surfaces

We offer four different surface structures, each of which have their own aesthetic effect.



woodgrain



stucco



micro-profiled



smooth

Wood decors

Our wood decors are the top choice for anyone who wants to combine the warm appearance of wood with the advantages of an insulated door leaf.



Golden Oak



Dark Oak

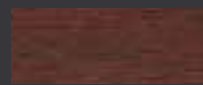

Rosewood



Winchester

RAL of your choice



Blazing Red
RAL 3000

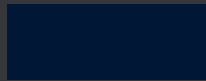

Steel Blue
RAL 5011

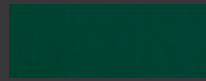

Moss Green
RAL 6005

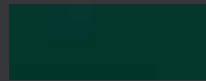

Fir Green
RAL 6009



15 popular colours and RAL colours of your choice – these provide you with all colour design possibilities. All surfaces are top coated and hence optimally protected from the very first day.

Due to the printing process colours are only representations.

RAL offers a guide to colour matching, materials, differing manufacturing processes and batches may create shade variations.

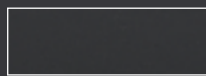

Anthracite Grey
RAL 7016

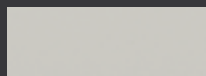

Light Grey
RAL 7035

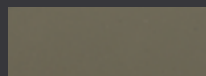

Quartz Grey
RAL 7039

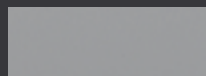

Window Grey
RAL 7040

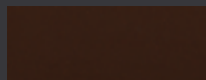

Sepia Brown
RAL 8014

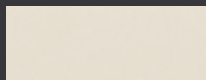

Creamy White
RAL 9001

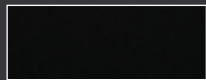

Deep Black
RAL 9005

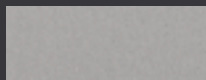

White Aluminum
RAL 9006

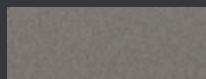

Grey Aluminum
RAL 9007



Grey tone
TT 703*



Brown tone
TT 8014*

* Colour tones with micaceous iron ore particles

Solid wood



Untreated



Pine



Spruce



Teak

For everybody that loves real wood. Our GSH-type solid wood doors have a high resistance to weather influences and UV radiation.



Walnut

Installation dimensions. Door and gate sizes.

Please take note of the following information about measurement to ensure precise installation and to guarantee precise, reliable function of the CarTeck sectional garage door.

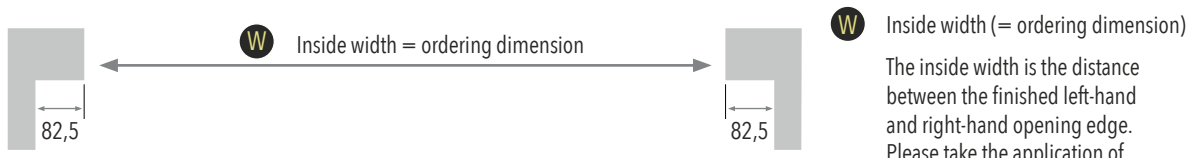
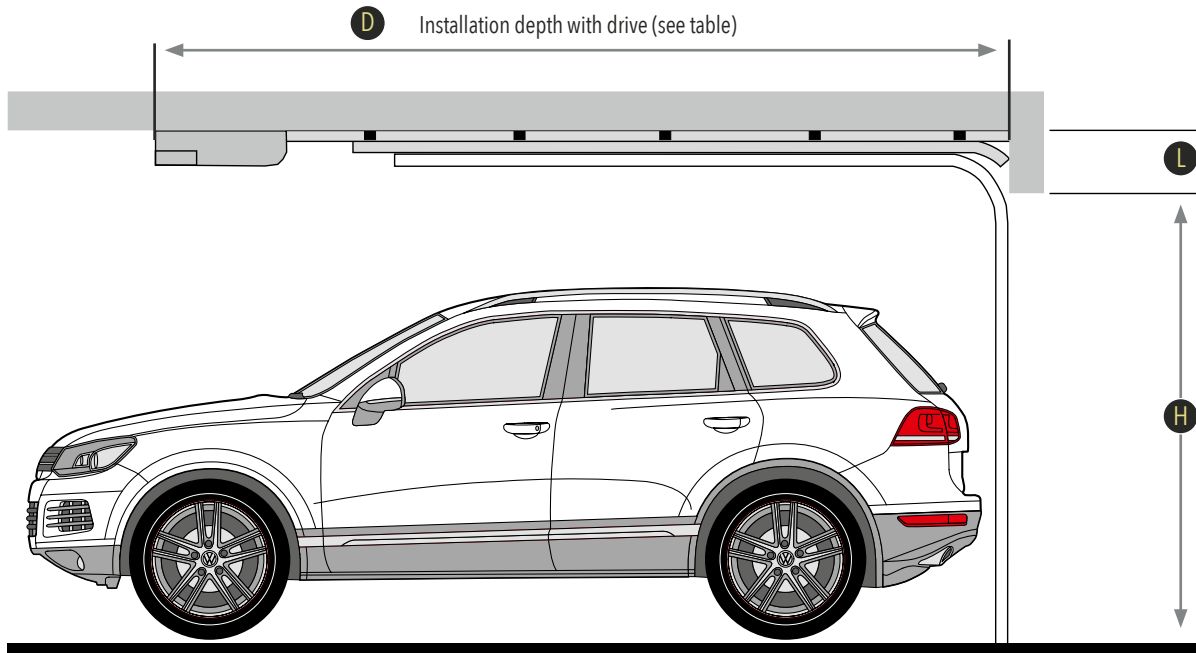

H Inside height (= ordering dimension)
The inside height is the distance between the upper edge of the finished floor to the lower edge of the lintel.
Please take the reduction in this distance due to the application of screed or asphalt into account in your planning where relevant.

L Lintel requirement
In the case of very large doors, reinforced roller brackets ensure durable function. This will increase the lintel requirement by 25 mm (see marking in the table).

Equipment	Lintel requirement	Internal headroom
with drive with drive	120 mm 240 mm	completely free - standard equipment completely free - special equipment with preliminary package - 125 mm extended top roller brackets
Manual operation Manual operation	240 mm 240 mm	completely free - special equipment with door stopper approx. – 25 mm - standard equipment
Manual operation Manual operation	120 mm 120 mm	approx. – 80 mm - special equipment with door stopper approx. – 150 mm - special equipment

H	
3000	
2875	
2750	
2625	
2500	
2375	
2250	
2175	
2125	
2050	
2000	
1925	
1875	
W	
Width (mm)	2000 2250 2375 2500 2625 2750 3000 3250 3500 3750 4000 4250 4500 4750 5000 5250 5500
Recommendation Drive:	20.2 40.2
D	
Installation depth	3320mm 3570mm 4070mm

NOTE: In the case of manually-operated doors, the insertion depth is reduced. Please ask your specialist dealer about this.

In the case of sectional doors with drives, the door height plus a length of approx. 1070 mm gives the required installation depth. A simple calculation. Nevertheless, many other marginal conditions must be taken into consideration for both renovations and new buildings. For this reason, you should contact a Teckentrup dealer in advance, who will conduct the measurements and will gladly help you with any other queries relating to your new sectional garage door.

The dimensions specified in the table serve for orientation. Naturally, all intermediate dimensions are individually manufactured. The door leaf and drive must match each other irrespective of your selected door size and width.

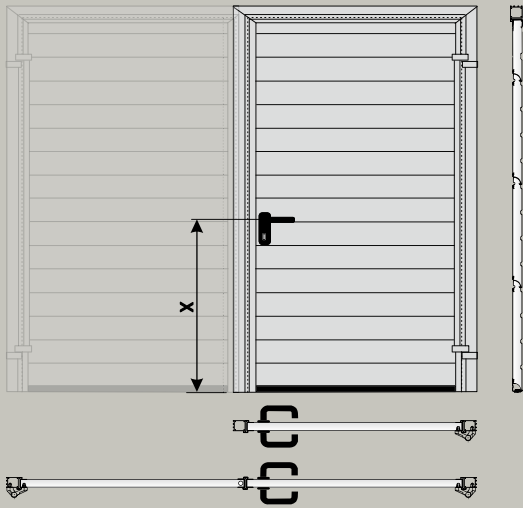

Door height	Height of the sections	* Dimension x
2500 mm	493 mm	935 mm
2375 mm	469 mm	1140 mm
2250 mm	556 mm	1035 mm
2125 mm	523 mm	985 mm
2000 mm	493 mm	935 mm
1875 mm	469 mm	1140 mm

* Door handle height: Value depending on system axis

Installation behind the soffit only for inward opening door

Image of active leaf DIN left, active leaf DIN right mirror image

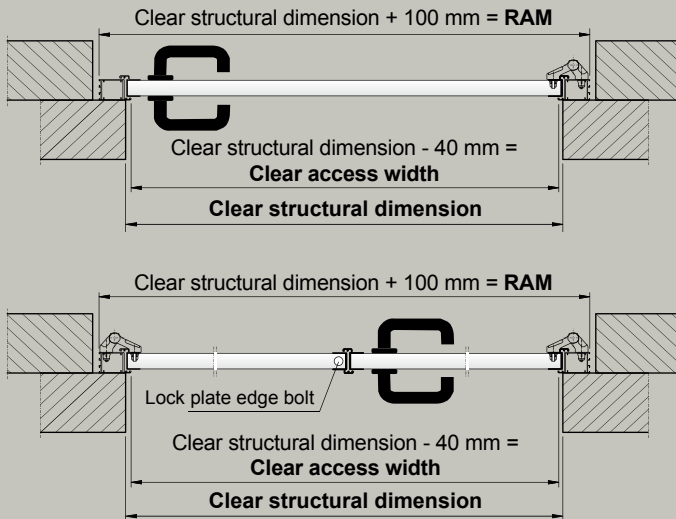

Installation in the soffit for inward and outward opening door

Image of active leaf DIN left, active leaf DIN right mirror image

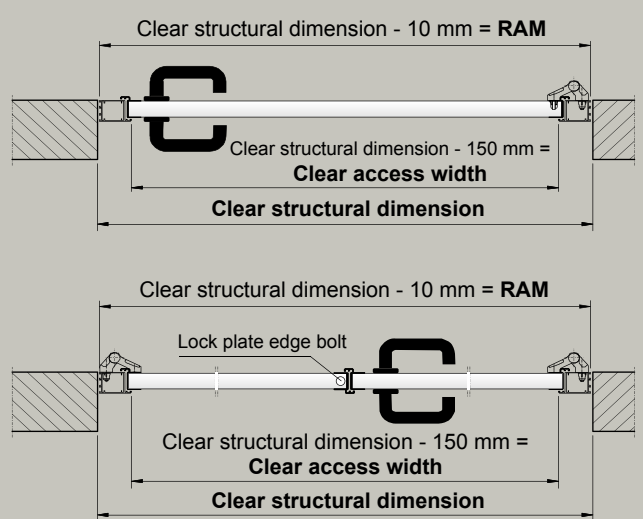

Installation behind the soffit only for inward opening door

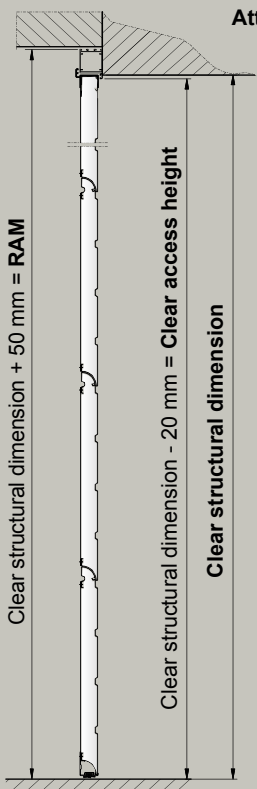

Attention: Outer dimension of framework = Ordering dimension

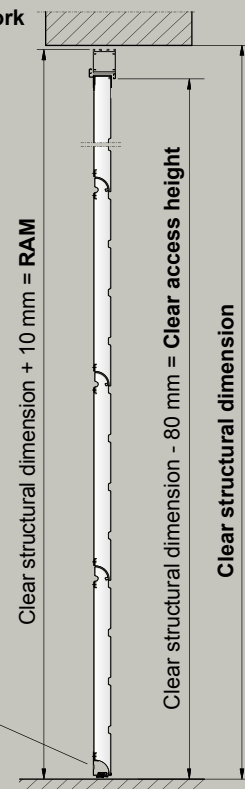
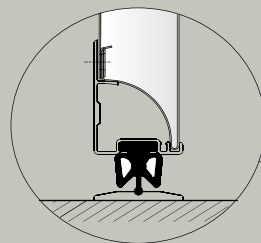

Installation in the soffit for inward and outward opening door

Expedient addition. Quality doors for your home.

Anyone renovating or building generally need doors with different functions. As one of Europe's leading manufacturers of doors and gates, we offer quality doors which make your home safer.

We offer:

- Security doors
- Fire protection doors
- Smoke protection doors
- Multi-purpose doors



Find more information at:
www.teckentrup.co.uk



Teckentrup. Always close to you.

Other countries (and regions/cities):

- Egypt
- Armenia
- India
- Iran
- Israel
- Kazakhstan
- Oman
- Southern Africa
- Thailand



www.teckentrup.co.uk

Dealer imprint

Teckentrup UK Ltd
 Units 7,8 & 9
 Gemini Trade Park
 Europa Boulevard
 WARRINGTON
 Cheshire
 WA5 7YF

T: 01925 924 050 F: 08701 314 843
 E: sales@teckentrupdepot.co.uk



We reserve the right to make technical changes. 05/03/15
 (GB) 119.315. The product images in this brochure are to be
 regarded as examples. The fitted products therefore do not
 necessarily correspond to the reference offers.